

60Hz POWER RATINGS

Voltage AC	Phase	PF	Standby		Prime*	
			KW	A	Kw	A
120/240	1	1	12	50	11	48
120/208	3	0.8	13	44	12	42
277/480	3	0.8	13	19	12	18

* Prime power rating for reference only.

Overview of the SIMMAX series of Industrial Generator Sets

Simson-Maxwell generators are factory-built in facilities that utilize the latest technology, mechanical and electrical component assembly, production, and testing. Each model is the result of computer-aided design and modeling backed up by exhaustive prototype-testing. Our development technology results in a unique range of innovative designs for highly reliable generator sets backed-up by a comprehensive warranty covering all components.

Standard Configuration of Industrial Sets

- Long-life, heavy-duty, 4-cycle, direct injection diesel engine from a world-renowned manufacturer for economy of operation and maximum reliability and durability. Capable of full-rated load acceptance in one step.
- Cooling: Radiator with belt driven pusher fan.
- Filtration: Heavy duty replaceable element air-cleaner.
- Alternator: Single bearing, 4-pole, rotating field, self-excited, self-ventilated, 12-wire re-connectable (6-wire dedicated for 600V), 60Hz brushless alternator with Class H insulation. Automatic voltage regulator (AVR) providing close voltage regulation.
- Arrangement: Open skid with engine and alternator units close coupled together and with seismic anti-vibration isolators mounted between the assembly and a heavy-duty steel base. Lifting lugs are provided as per application.
- Auto Start Control Panel: Digital auto-start microprocessor based control panel with remote start capability.
- Starting System: Electric starter motor, battery cables, battery and belt driven charging alternator.
- CSA certified and meets CSA C282 requirements.

ENGINE SPECIFICATION

Manufacturer	Deutz
Model	D2011L02i
EPA certified	Tier-4F
Crank shaft speed: rpm	1800
Fuel type	Diesel
Injection	Direct
Aspiration	Turbocharged
Number of cylinder	2
Cylinder arrangement	Inline
Displacement: L	1.6
Bore: mm	94
Stroke: mm	112
Engine standby power: kW	15.1
Engine prime power: kW	14.4
Cooling	Water cooled
Governor	Electronic-EMR2
Starting motor voltage	12V DC
Compression ration	19.0:1
Air cleaner type	Dry type with paper element

EXHAUST SYSTEM

Maximum engine exhaust temperature: °F (°C)	950	(510)
Exhaust gas flow: CFM (m3/hr)	118.0	(200.5)
Max. permissible back pressure: PSI (kPA)	0.436	(3)

COOLING SYSTEM *

Radiator cooling air flow: CFM (m3/hr)	750	(1275)	@Max 40°C ambient temperature
Max. restriction of cooling air: in.w.g. (kPA)	0.603	(0.2)	
Engine combustion air flow: CFM (m3/hr)	40	(68)	
Total intake air requirement: CFM (m3/hr)	790	(1342.3)	
Total coolant capacity: Litre	6.5		

HEAT BALANCE

Heat at rejection to coolant: kW	2.5
Heat at rejection radiation from engine: kW	TBA
Heat at rejection to engine exhaust: kW	TBA

LUBRICATION SYSTEM

Oil pan capacity: Litre	6.0
Oil pan capacity with filter: Litre	8.0
Oil cooler	Integrated oil cooler
Recommended lubricating oil grade	TR0199-99-1217
Oil consumption at full load: Litre/hr	0.003
Oil pressure: PSI (kPA)	29.1 (200)

* SIMMAX recommends to limit the building air intake velocity to 650ft/minute, and the discharge air velocity to 750 ft/min.

SIMMAX



**POWER
GENERATION**

DIESEL PRODUCT LINE

SDW12 T6-T4

120/240/208/480 Volts

60 Hz/1800 RPM | Standby/Prime

ENGINE ELECTRICAL SYSTEM

Starting motor voltage	12V DC
Battery capacity	4D, 12V, 1000A
Cranking Amps minimum	66AH at -5°C

FUEL SYSTEM

Recommended fuel	ASTM D 975 1-D/2-DJIS K2204 Grade-1/-2
Fuel supply line, min. ID: mm	15.0
Fuel return line min. ID: mm	15.0
Fuel supply line max. restriction: kpa	25
Fuel pump type	Engine-driven
Fuel filter	Single stage Oil and Fuel Filter

FUEL CONSUMPTION

	Standby Power		Prime Power
100% Load Standby: Litre/hr	4.6	100% Load Prime: Litre/hr	4.2
75% Load Standby: Litre/hr	3.4	75% Load Prime: Litre/hr	3.1
50% Load Standby: Litre/hr	2.3	50% Load Prime: Litre/hr	2.1
25% Load Standby: Litre/hr	1.4	25% Load Prime: Litre/hr	1.3

ALTERNATOR SPECIFICATION

Alternator manufacturer	STAMFORD
Alternator model	PI044
Voltage	120V - 480V
Alternator type	Four pole, Rotating field
Excitation system	Brushless, Self excited (EBS option available)
Power factor	0.8
Number of leads	12 leads reconnectable (120V-480V)
Stator pitch	2/3
Insulation	Class H
Windings - temperature rise / Ambient °C	125 / 40
Enclosure rating	IP23
Bearing	Single, Sealed
Amortisseur windings	Full
Voltage regulation - no load to full load with DSR AVR	± 1%
TIF	<50
Line harmonics	5% MAXIMUM
Alternator cooling air flow: CFM (m3/hr)	286 (486)

STANDARD FEATURES

• Radiator with pusher fan	• Standard fuel filter
• Medium-duty, Dry type with paper element	• All rotating components protected with metal guards
• Heavy-duty engine start batteries with cables	• Operation and installation literature
• Emergency stop switch	• CSA certified
• Control Panel (See next page for details)	• Steel base for mounting on fuel tank/concrete surface

OPTIONAL FEATURE: SUB-BASE FUEL TANK *

Runtime	24 hour	48 hour	72 hour
Tank volume - US gal (L)	29.3 (110.9)	58.6 (221.8)	87.9 (332.7)
Tank size: L x W x H - inch	50 x 27 x 9	50 x 27 x 13	50 x 27 x 19
Tank size: L x W x H - m	1.3 x 0.7 x 0.3	1.3 x 0.7 x 0.4	1.3 x 0.7 x 0.5

* All measurements are approximate and for estimation purposes only. The tank dimensions may vary. For specific sizes, contact sales representative.

Rev: A

Date: 3/29/2018

Control Systems Standard Features - Generator Digital Control Panel

Standard Configuration of Control Systems

- Numerous control systems available, depending on customer requirements
- Automatic or manual start/stop
- Pre-lube function with timers
- Adjustable crank attempts
- Engine warm up/cooling functions
- Digital metering with alarms and shutdowns
- LCD display
- LED indicators
- In-built PLC function
- RS232 (optional RS485 or CAN) communication
- Data logging up to 350 events
- Password protection



Key dimensions and Weights

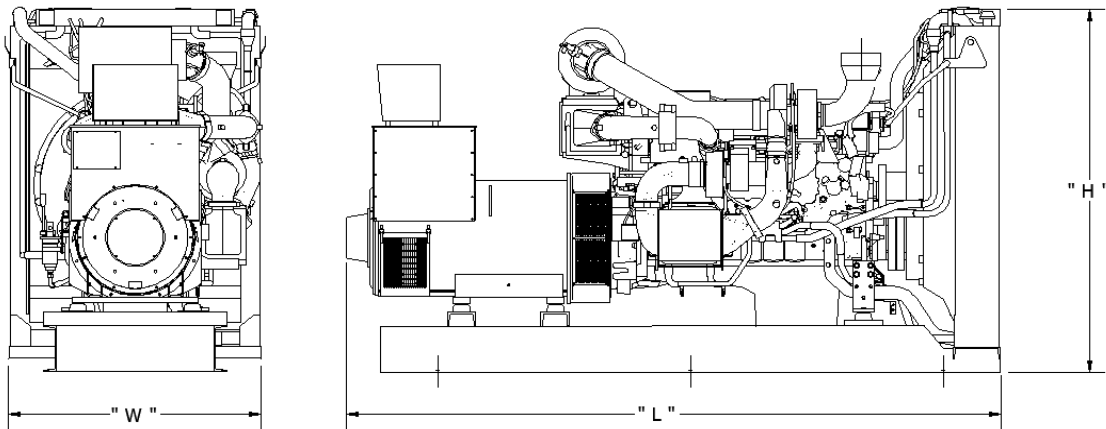

GENERATOR DATA *			
L = LENGTH - inch (mm)	W = WIDTH - inch (mm)	H = HEIGHT - inch (mm)	DRY WEIGHT - lbs (kg)
49 (1244.6)	26 (660.4)	33.0 (838.2)	817.3 (370.7)

* All measurements are approximate and for estimation purposes only. Images are reference only.
 Any deviation can change dimensions.
 Materials and specifications subject to change without notice.



Simson Maxwell

Calgary | Edmonton | Nanaimo | Port Coquitlam | Prince George | Terrace | Ft. St. John

www.simson-maxwell.com | 800-374-6766

