

60Hz POWER RATINGS

Voltage AC	Phase	PF	Standby		Prime*	
			KW	A	Kw	A
277/480	3	0.8	3368	5064	2644	3975
347/600	3	0.8	3368	4051	2644	3180
2402/4160	3	0.8	3368	584	2644	459
12470	3	0.8	3368	195	2644	153

* Prime power rating for reference only.

Overview of the SIMMAX series of Industrial Generator Sets

Simson-Maxwell generators are factory-built in facilities that utilize the latest technology, mechanical and electrical component assembly, production, and testing. Each model is the result of computer-aided design and modeling backed up by exhaustive prototype-testing. Our development technology results in a unique range of innovative designs for highly reliable generator sets backed-up by a comprehensive warranty covering all components.

Standard Configuration of Industrial Sets

- Long-life, heavy-duty, 4-cycle, direct injection diesel engine from a world-renowned manufacturer for economy of operation and maximum reliability and durability. Capable of full-rated load acceptance in one step.
- Cooling: Radiator with belt driven pusher fan.
- Filtration: Heavy duty replaceable element air-cleaner.
- Alternator: Single bearing, 4-pole, rotating field, self-excited, self-ventilated, 12-wire re-connectable (6-wire dedicated for 600V), 60Hz brushless alternator with Class H insulation. Automatic voltage regulator (AVR) providing close voltage regulation.
- Arrangement: Open skid with engine and alternator units close coupled together and with seismic anti-vibration isolators mounted between the assembly and a heavy-duty steel base. Lifting lugs are provided as per application.
- Auto Start Control Panel: Digital auto-start microprocessor based control panel with remote start capability.
- Starting System: Electric starter motor, battery cables, battery and belt driven charging alternator.
- CSA certified and meets CSA C282 requirements.

SIMMAX



**POWER
GENERATION**

DIESEL PRODUCT LINE

SMTW3000 T6-T2

120/240/208/480/600 Volts

60 Hz/1800 RPM | Standby/Prime

ENGINE SPECIFICATION

Manufacturer	MTU
Model	20V4000G83L
EPA certified	Tier-2
Crank shaft speed: rpm	1800
Fuel type	Diesel
Injection	Direct
Aspiration	Turbocharged
Number of cylinder	20
Cylinder arrangement	90°V
Displacement: L	95.4
Bore: mm	170
Stroke: mm	210
Engine standby power: kW	3490.0
Engine prime power: kW	2740.0
Cooling	Water cooled
Governor	Electronic-ADEC
Starting motor voltage	24V DC
Compression ration	16.4:1
Air cleaner type	Heavy Duty Air Filter

EXHAUST SYSTEM

Maximum engine exhaust temperature: °F (°C)	977 (525)
Exhaust gas flow: CFM (m3/hr)	24791.0 (42120.2)
Max. permissible back pressure: PSI (kPA)	1.233 (8.5)

COOLING SYSTEM

Radiator cooling air flow: CFM (m3/hr)	108843 (184926)	@Max 40°C ambient temperature
Max. restriction of cooling air: in.w.g. (kPA)	0.483 (0.2)	
Engine combustion air flow: CFM (m3/hr)	9323 (15840)	
Total intake air requirement: CFM (m3/hr)	118166 (200765.4)	
Total coolant capacity: Litre	860	

HEAT BALANCE

Heat at rejection to coolant: kW	2270.0
Heat at rejection radiation from engine: kW	230.0
Heat at rejection to engine exhaust: kW	TBA

LUBRICATION SYSTEM

Oil pan capacity: Litre	TBA
Oil pan capacity with filter: Litre	390.0
Oil cooler	Integrated full flow
Recommended lubricating oil grade	TBA
Oil consumption at full load: Litre/hr	7.84
Oil pressure: PSI (kPA)	79.8 (550)

SIMMAX



**POWER
GENERATION**

DIESEL PRODUCT LINE

SMTW3000 T6-T2

120/240/208/480/600 Volts

60 Hz/1800 RPM | Standby/Prime

ENGINE ELECTRICAL SYSTEM

Starting motor voltage	24V DC
Battery capacity	2X8D, 24V, 1500A
Cranking Amps minimum	4200A @-17.8°C

FUEL SYSTEM

Recommended fuel	Diesel#2
Fuel supply line, min. ID: mm	25.0
Fuel return line min. ID: mm	25.0
Fuel supply line max. restriction: kpa	8.34
Fuel pump type	Engine-driven
Fuel filter	0.005mm Fuel Filter

FUEL CONSUMPTION

	Standby Power		Prime Power
100% Load Standby: Litre/hr	784.0	100% Load Prime: Litre/hr	712.7
75% Load Standby: Litre/hr	594.0	75% Load Prime: Litre/hr	540.0
50% Load Standby: Litre/hr	413.0	50% Load Prime: Litre/hr	375.5
25% Load Standby: Litre/hr	-	25% Load Prime: Litre/hr	-

ALTERNATOR SPECIFICATION

Alternator manufacturer	Leroy-Somer
Alternator model	LSA53
Voltage	480V, 600V (Option available)
Alternator type	Four pole, Rotating field
Excitation system	AREP + PMI (PMG option available)
Power factor	0.8
Number of leads	TBA
Stator pitch	2/3
Insulation	Class H
Windings - temperature rise / Ambient °C	125 / 40
Enclosure rating	IP23
Bearing	Single, Sealed
Amortisseur windings	Full
Voltage regulation - no load to full load with DSR AVR	± 0.5%
TIF	<50
Line harmonics	5% MAXIMUM
Alternator cooling air flow: CFM (m3/hr)	6000 (10195)

STANDARD FEATURES

• Radiator with pusher fan	• Standard fuel filter
• Medium-duty, Heavy Duty Air Filter	• All rotating components protected with metal guards
• Heavy-duty engine start batteries with cables	• Operation and installation literature
• Emergency stop switch	• CSA certified
• Control Panel (See next page for details)	• Steel base for mounting on fuel tank/concrete surface

OPTIONAL FEATURE: SUB-BASE FUEL TANK *

Runtime	24 hour	48 hour	72 hour
Tank volume - US gal (L)	4970.7 (18816)	9941.3 (37632)	14911.9 (56448)
Tank size: L x W x H - inch	307 x 123 x 34	315 x 189 x 40	315 x 281 x 40
Tank size: L x W x H - m	7.8 x 3.1 x 0.9	8 x 4.8 x 1	8 x 7.2 x 1

* All measurements are approximate and for estimation purposes only. The tank dimensions may vary. For specific sizes, contact sales representative.

Rev: A

Date: 3/29/2018

Control Systems Standard Features - Generator Digital Control Panel

Standard Configuration of Control Systems

- Numerous control systems available, depending on customer requirements
- Automatic or manual start/stop
- Pre-lube function with timers
- Adjustable crank attempts
- Engine warm up/cooling functions
- Digital metering with alarms and shutdowns
- LCD display
- LED indicators
- In-built PLC function
- RS232 (optional RS485 or CAN) communication
- Data logging up to 350 events
- Password protection



Key dimensions and Weights

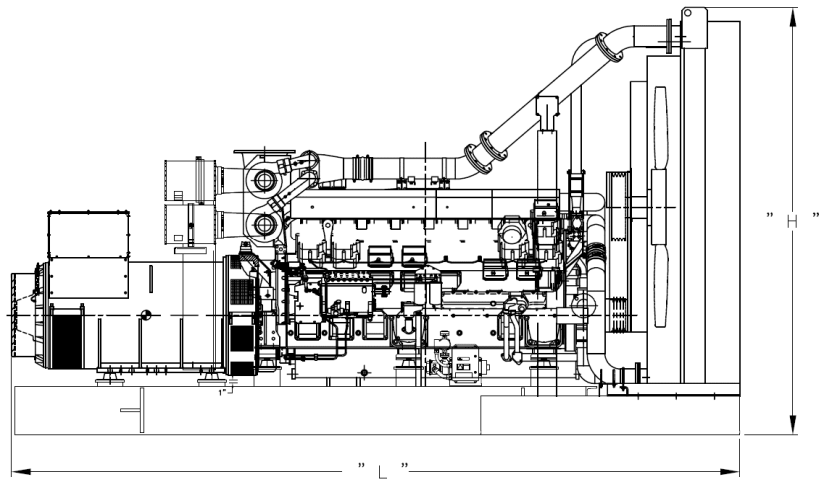
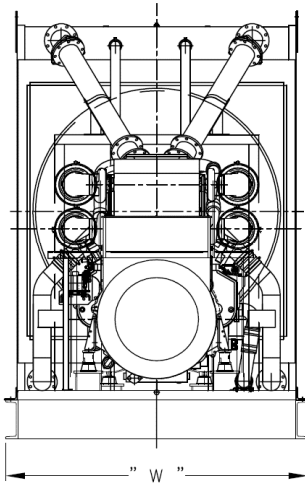

GENERATOR DATA *

L = LENGTH - inch (mm)	W = WIDTH - inch (mm)	H = HEIGHT - inch (mm)	DRY WEIGHT - lbs (kg)
306 (7772.4)	122 (3098.8)	140.0 (3556)	58150.3 (26372.1)

* All measurements are approximate and for estimation purposes only. Images are reference only.

Any deviation can change dimensions.

Materials and specifications subject to change without notice.



Simson Maxwell

Calgary | Edmonton | Nanaimo | Port Coquitlam | Prince George | Terrace | Ft. St. John

www.simson-maxwell.com | 800-374-6766

