

60Hz POWER RATINGS

Voltage AC	Phase	PF	Standby		Prime*	
			KW	A	Kw	A
120/240	1	1	294	1226	266	1110
120/208	3	0.8	296	1027	268	930
277/480	3	0.8	297	447	269	404
347/600	3	0.8	298	359	270	325

* Prime power rating for reference only.

Overview of the SIMMAX series of Industrial Generator Sets

Simson-Maxwell generators are factory-built in facilities that utilize the latest technology, mechanical and electrical component assembly, production, and testing. Each model is the result of computer-aided design and modeling backed up by exhaustive prototype-testing. Our development technology results in a unique range of innovative designs for highly reliable generator sets backed-up by a comprehensive warranty covering all components.

Standard Configuration of Industrial Sets

- Long-life, heavy-duty, 4-cycle, direct injection diesel engine from a world-renowned manufacturer for economy of operation and maximum reliability and durability. Capable of full-rated load acceptance in one step.
- Cooling: Radiator with belt driven pusher fan.
- Filtration: Heavy duty replaceable element air-cleaner.
- Alternator: Single bearing, 4-pole, rotating field, self-excited, self-ventilated, 12-wire re-connectable (6-wire dedicated for 600V), 60Hz brushless alternator with Class H insulation. Automatic voltage regulator (AVR) providing close voltage regulation.
- Arrangement: Open skid with engine and alternator units close coupled together and with seismic anti-vibration isolators mounted between the assembly and a heavy-duty steel base. Lifting lugs are provided as per application.
- Auto Start Control Panel: Digital auto-start microprocessor based control panel with remote start capability.
- Starting System: Electric starter motor, battery cables, battery and belt driven charging alternator.
- CSA certified and meets CSA C282 requirements.

ENGINE SPECIFICATION

Manufacturer	Volvo
Model	TAD1341GE
EPA certified	Tier-2
Crank shaft speed: rpm	1800
Fuel type	Diesel
Injection	Direct
Aspiration	Turbocharged
Number of cylinder	6
Cylinder arrangement	Inline
Displacement: L	12.78
Bore: mm	131
Stroke: mm	158
Engine standby power: kW	317.0
Engine prime power: kW	287.0
Cooling	Water cooled
Governor	Electronic-EMS2.2
Starting motor voltage	24V DC
Compression ration	18.1:1
Air cleaner type	Air filter with replaceable paper insert

EXHAUST SYSTEM

Maximum engine exhaust temperature: °F (°C)	757.4 (403)
Exhaust gas flow: CFM (m3/hr)	2190.0 (3720.9)
Max. permissible back pressure: PSI (kPA)	1.451 (10)

COOLING SYSTEM

Radiator cooling air flow: CFM (m3/hr)	17375 (29521)	@Max 40°C ambient temperature
Max. restriction of cooling air: in.w.g. (kPA)	0.531 (0.2)	
Engine combustion air flow: CFM (m3/hr)	1023 (1739)	
Total intake air requirement: CFM (m3/hr)	18398 (31258.5)	
Total coolant capacity: Litre	44	

HEAT BALANCE

Heat at rejection to coolant: kW	148.0
Heat at rejection radiation from engine: kW	22.0
Heat at rejection to engine exhaust: kW	235.0

LUBRICATION SYSTEM

Oil pan capacity: Litre	30.0
Oil pan capacity with filter: Litre	36.0
Oil cooler	Integrated full flow
Recommended lubricating oil grade	VSD3/VSD2
Oil consumption at full load: Litre/hr	0.05
Oil pressure: PSI (kPA)	65.3 (450)

SIMMAX



**POWER
GENERATION**

DIESEL PRODUCT LINE

SVW300 T6-T2

120/240/208/480/600 Volts
60 Hz/1800 RPM | Standby/Prime

ENGINE ELECTRICAL SYSTEM

Starting motor voltage	24V DC
Battery capacity	4D, 12V, 1000A
Cranking Amps minimum	180 A at +20 °C

FUEL SYSTEM

Recommended fuel	ASTM-D975-No1 and 2-DJIS KK 2204, EN 590
Fuel supply line, min. ID: mm	15.0
Fuel return line min. ID: mm	15.0
Fuel supply line max. restriction: kpa	30
Fuel pump type	Engine-driven
Fuel filter	Fuel filter 0.005mm Prefilter 0.010mm

FUEL CONSUMPTION

	Standby Power		Prime Power
100% Load Standby: Litre/hr	78.8	100% Load Prime: Litre/hr	71.8
75% Load Standby: Litre/hr	60.5	75% Load Prime: Litre/hr	55.4
50% Load Standby: Litre/hr	43.4	50% Load Prime: Litre/hr	40.1
25% Load Standby: Litre/hr	27.7	25% Load Prime: Litre/hr	25.0

ALTERNATOR SPECIFICATION

Alternator manufacturer	STAMFORD
Alternator model	HCI434
Voltage	120V - 480V, 600V
Alternator type	Four pole, Rotating field
Excitation system	Brushless, PMG (MX341)
Power factor	0.8
Number of leads	12 leads reconnectable (120V-480V-600V)
Stator pitch	2/3
Insulation	Class H
Windings - temperature rise / Ambient °C	125 / 40
Enclosure rating	IP23
Bearing	Single, Sealed
Amortisseur windings	Full
Voltage regulation - no load to full load with DSR AVR	± 1%
TIF	<50
Line harmonics	5% MAXIMUM
Alternator cooling air flow: CFM (m3/hr)	2100 (3568)

STANDARD FEATURES

• Radiator with pusher fan	• Standard fuel filter
• Medium-duty, Air filter with replaceable paper insert	• All rotating components protected with metal guards
• Heavy-duty engine start batteries with cables	• Operation and installation literature
• Emergency stop switch	• CSA certified
• Control Panel (See next page for details)	• Steel base for mounting on fuel tank/concrete surface

OPTIONAL FEATURE: SUB-BASE FUEL TANK *

Runtime	24 hour	48 hour	72 hour
Tank volume - US gal (L)	499.8 (1891.8)	999.5 (3783.6)	1499.3 (5675.3)
Tank size: L x W x H - inch	122 x 49 x 23	125 x 49 x 40	187 x 49 x 40
Tank size: L x W x H - m	3.1 x 1.3 x 0.6	3.2 x 1.3 x 1	4.8 x 1.3 x 1

* All measurements are approximate and for estimation purposes only. The tank dimensions may vary. For specific sizes, contact sales representative.

Rev: A

Date: 3/29/2018

Control Systems Standard Features - Generator Digital Control Panel

Standard Configuration of Control Systems

- Numerous control systems available, depending on customer requirements
- Automatic or manual start/stop
- Pre-lube function with timers
- Adjustable crank attempts
- Engine warm up/cooling functions
- Digital metering with alarms and shutdowns
- LCD display
- LED indicators
- In-built PLC function
- RS232 (optional RS485 or CAN) communication
- Data logging up to 350 events
- Password protection



Key dimensions and Weights

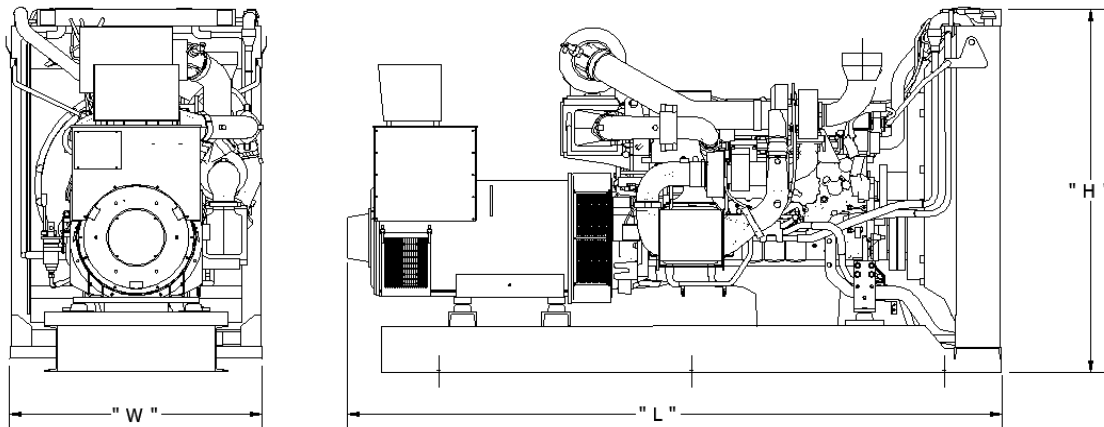

GENERATOR DATA *

L = LENGTH - inch (mm)	W = WIDTH - inch (mm)	H = HEIGHT - inch (mm)	DRY WEIGHT - lbs (kg)
121 (3073.4)	48 (1219.2)	66.5 (1689.1)	6885.6 (3122.7)

* All measurements are approximate and for estimation purposes only. Images are reference only.

Any deviation can change dimensions.

Materials and specifications subject to change without notice.



Simson Maxwell

Calgary | Edmonton | Nanaimo | Port Coquitlam | Prince George | Terrace | Ft. St. John

www.simson-maxwell.com | 800-374-6766

